

Miele®

Operating instructions for the dishwasher G 595 SC

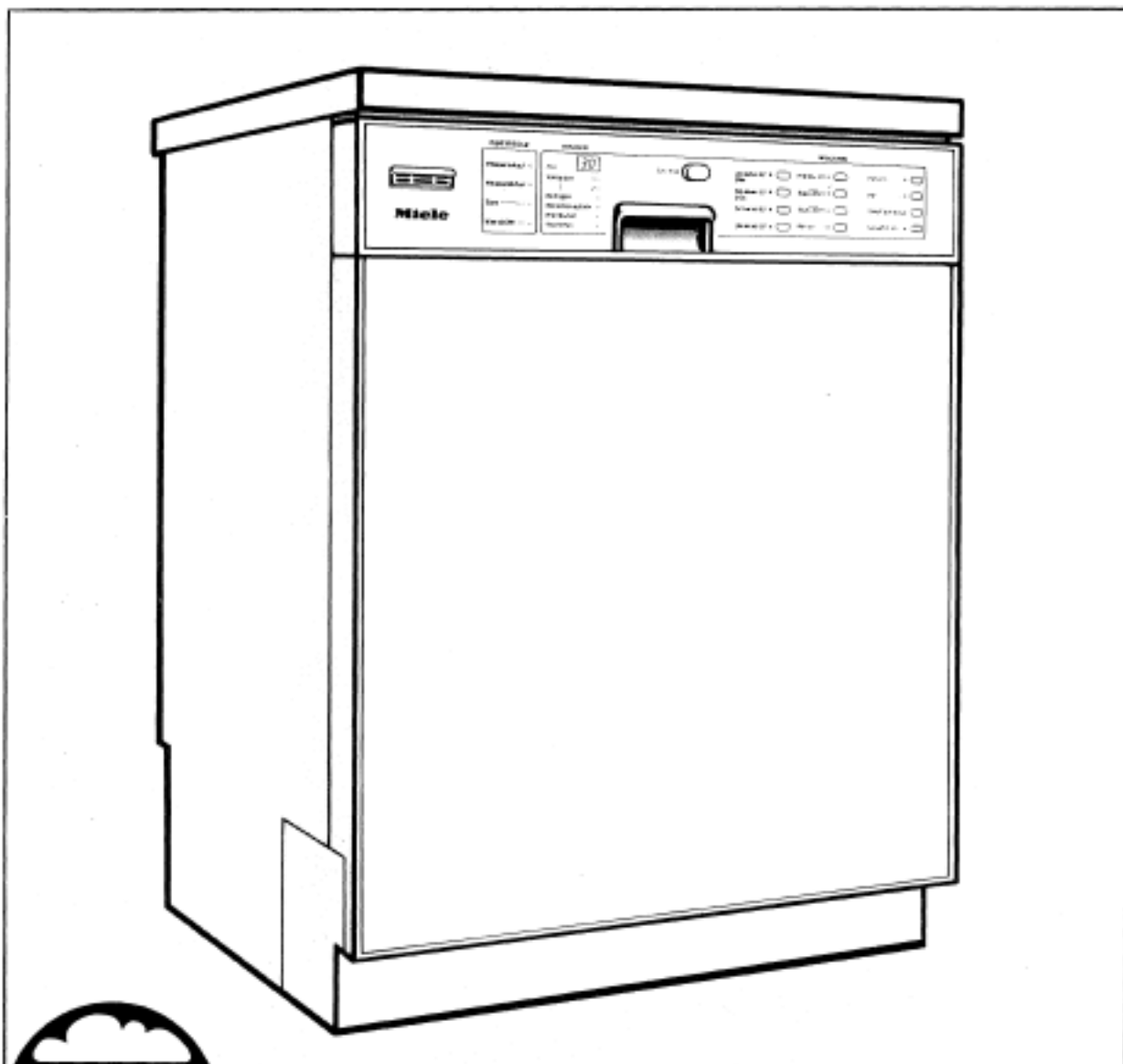

CARING FOR
THE ENVIRONMENT

This paper is manufactured from straw cellulose. Straw is a natural agricultural residue from cereal production and its use in paper helps to save more trees.

USA

T.-Nr. 2881302/04

	Page
Description of Appliance	3
Important Safety Instructions	5
Economy Wash	6
Opening and Closing the Door	7
Water Softener	8
Adding Rinse Aid	12
Loading Dishwasher	14
Loading Examples (G 595 SC)	15
Adjusting Upper Basket	18
Not suitable for Dishwasher	19
Adding Detergent	20
Selecting Program	21
Types of Programs	22
Switching ON and OFF	24
Changing Program	24
Selecting Additional Program: "Non-heated drying"	24
"Pre-selection 1-9 hrs"	25
To interrupt a program	25
Unloading Dishwasher	26
Additional Functions	27
- Water Inlet – time-controlled/level-controlled	28
- Drying – vented or non-vented	28
- Cycle-time display	28
Cleaning and Care	29
Dealing with Minor Faults	33
Installation	35
Electrical Connection	36
Plumbing	37
Technical Data	38

Description of Appliance

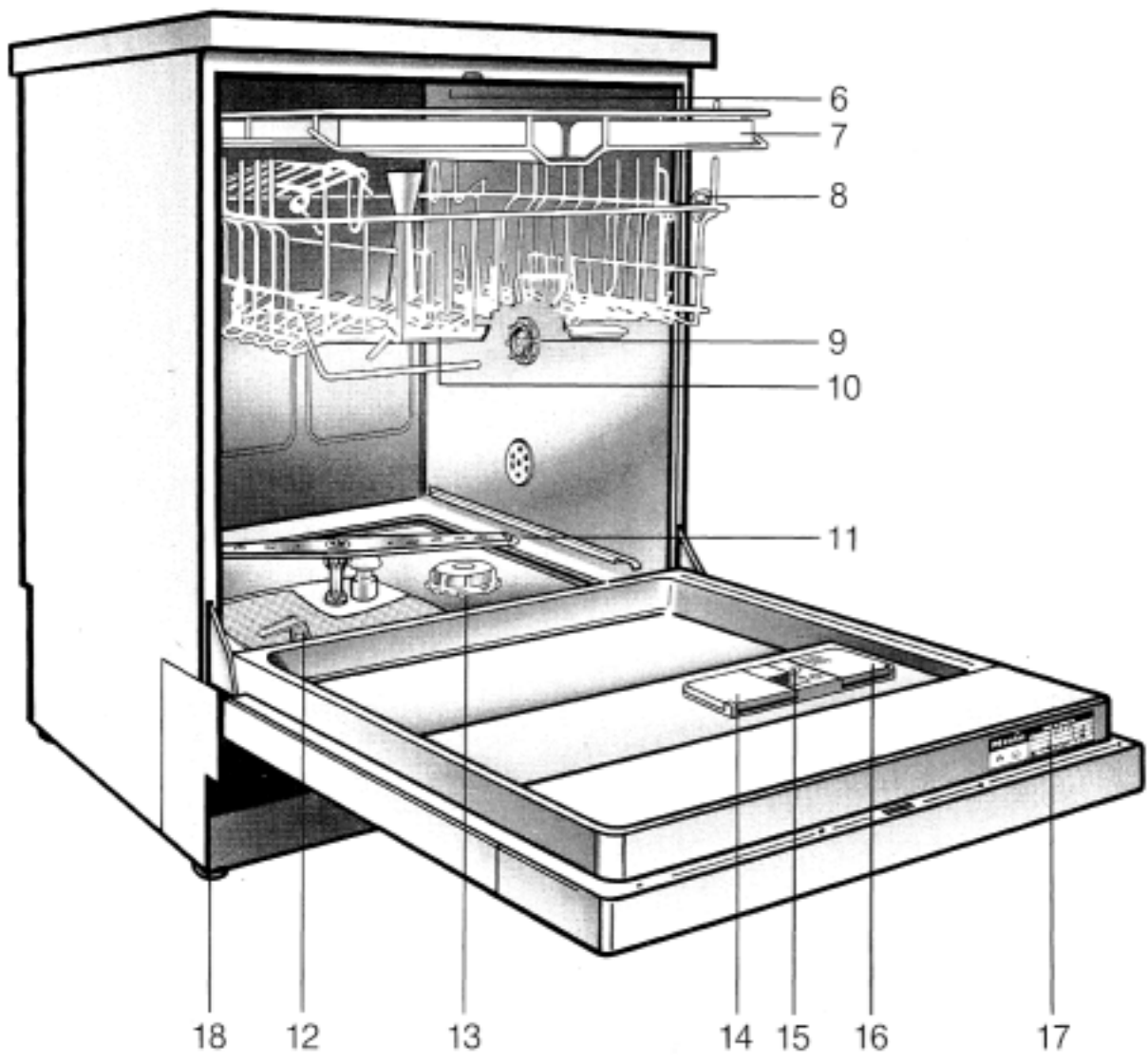
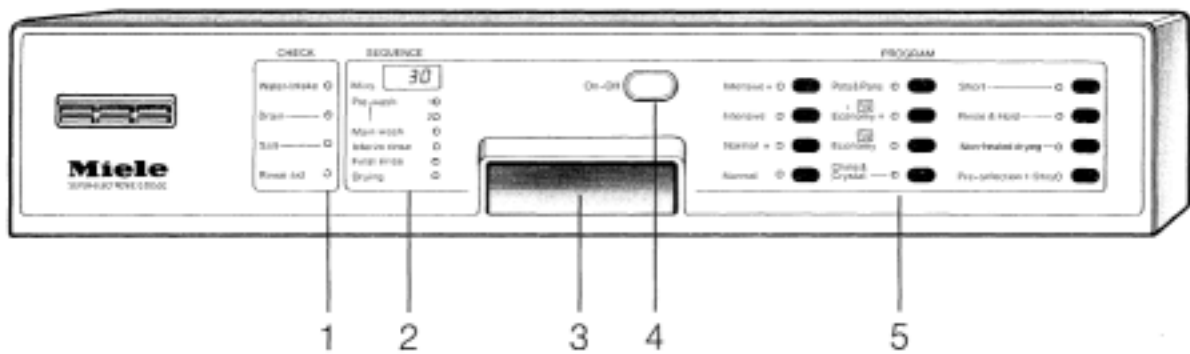

Description of Appliance

1. Indicator Lights
2. Program Sequence Indicator
3. Door Release
4. On-Off Button
5. Program Selection Buttons
6. Upper Spray Arm (not visible)
7. Cutlery Tray
8. Upper Basket
9. Water Hardness Selector
10. Center Spray Arm
11. Lower Spray Arm
12. Filter Combination
13. Storage Reservoir for Salt
14. Detergent Dispenser
15. Rinse Aid Indicator
16. Storage Container for Rinse Aid with Dosage Selector
17. Data Plate
18. Four Leveling Screw Feet

Make your contribution to protect our environment

Disposal of the packing material

The transport and protective packing is mostly manufactured from the following re-useable materials:

- corrugated paper/cards board
- polystyrene – CFC-free
- polyethylene foil (transparent)
- particle board – solvent-free
- untreated wood

Don't throw these materials away with your ordinary rubbish. Take them to the nearest collection point. Your local authority will tell you where it is.

Disposal of your old machine

There are materials in old machines which can be re-used, so please don't simply dispose of your old machine. Ask your local authority or scrap merchant whether those parts are re-useable or recyclable.

Important Safety Instructions

WARNING –

When using your dishwasher, follow basic precautions, including the following:

- Always read instructions before using the appliance. This prevents damage to the appliance and ensures your safety.
- Use the appliance only for its intended purpose.
- The appliance conforms with the uniform Safety Regulations. Repairs should only be carried out by qualified experts.
Disconnect the appliance from the power supply when servicing (pull out plug or remove fuse).
- Install built-in and integrated units only under a continuous worktop which is secured to adjacent cabinetry.
- The dishwasher must be electrically grounded. Read installation instructions for details.
- Use only recommended detergents and rinsing aids.
- Do not use your dishwasher unless all enclosure panels are properly in place.
- To reduce the risk of injury, do not allow children to play in or on a dishwasher.
- Dishwasher detergent contains Sodium Silicate and Sodium Carbonate. In case of eye contact, immediately flush well with water. If swallowed, give large quantities of milk or water. Call a physician. Keep out of reach of children.
- Do not tamper with controls.

- Do not drink the water from the wash cabinet!
- When loading items to be washed:
 - a. Locate sharp items so that they are not likely to damage the door seal, and
 - b. Load sharp knives with the handle up to reduce a risk of cut-type injuries.
- Do not wash plastic items unless marked "dishwasher safe" or the equivalent.
- For items not marked, check manufacturer's recommendations.
- Do not abuse, sit on, or stand on the door or dish rack of the dishwasher.
- Do not touch the heating elements during or immediately after the rinse cycle. Risk of burns!
- Remove the door to the washing compartment when removing an old dishwasher from service or discarding it.
- Hydrogen gas may build in the water heater and hot water pipes when the hot water system has not been used for two weeks or more.
CAUTION – hydrogen gas is explosive. If the hot water system has not been used for such a period, before using the dishwasher turn on all hot water faucets and let the water flow from each for several minutes. Do not use the dishwasher before doing so. As running hot water will release any accumulated hydrogen gas, do not smoke or use an open flame while the faucets are open.

SAVE THESE INSTRUCTIONS

Economy Wash

These dishwashers are extremely water and energy saving. Note the following hints:

- Connect dishwasher to hot water. This saves time and energy and protects the dishes.
Energy costs are further reduced if the water is pre-heated.
- Fill the baskets to full capacity, but do not overload.
- Select a program according to type of load and amount of soils.
- For half-loaded baskets, select "Economy" Program.
- Pay attention to dosage instructions for the detergent.

Opening and Closing the Door

To Open

- Hold handgrip and push up.

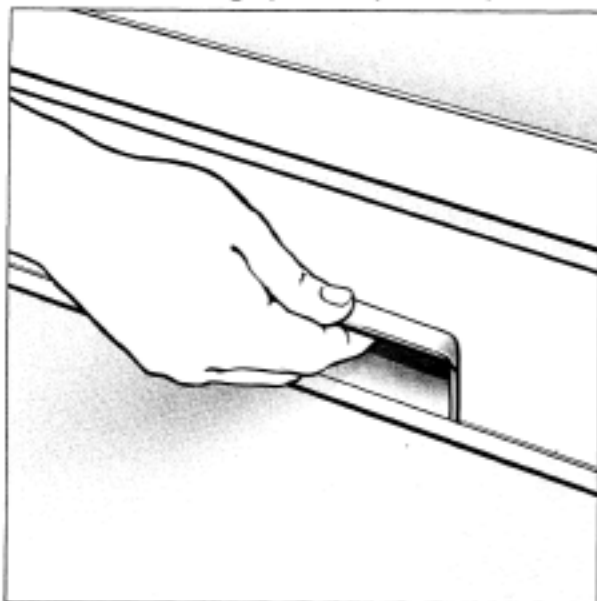

If door is opened during operation, all functions are automatically interrupted.

To Close

- Insert baskets.
- Pull door up and close until it catches.

Water Softener

To prevent mineral deposits on dishes and inside the dishwasher, the water must first be softened, if it is harder than 8 grains per gallon.

The built-in water softener works efficiently only if:

1. it is set correctly
2. the salt container is kept full.

Exception:

If the degree of hardness in local water is permanently under 8 grains per gallon (140 mg/liter) with low carbonate hardness, there is no need to reactivate. Your local water authority will advise you on water hardness in your area.

Water Hardness Selector

After consulting your local water authority to establish water hardness in your area, adjust the selector according to the table below, using a screwdriver or coin.

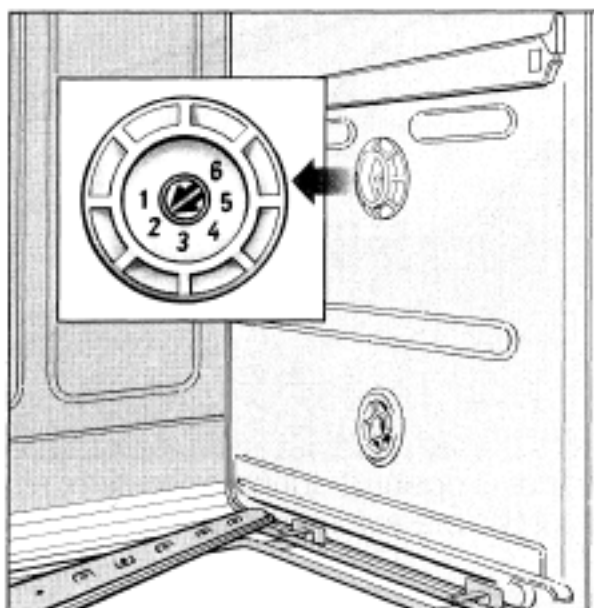

Water Hardness Selector Adjustments

6 positions are possible:

Pos.	Hardness level	mg/l	Grains per gallon
1	2	140- 250	8-14
2*	3	260- 380	15-22
3		390- 630	23-36
4		640- 840	37-48
5	4	850-1160	49-66
6		1170-1250	67-72

* set at factory

NOTE

If your dishwasher is set with fill time option, (see p. 28), the water hardness selector must be set one setting higher than for the normal water hardness setting (except with 1170-1250 mg/l).

Water Softener / Filling Salt Reservoir

Please use only special coarse-grained reactivation salt, as other salts may contain insoluble additives which can impair the functioning of the softener.

Inadvertently filling the salt container with dishwasher detergent will always lead to damage to the water softener.

Make sure that you have picked up the right packet of reactivating salt before filling the salt container.

- Remove lower basket
- Unscrew cap of salt reservoir

Before filling the salt reservoir for the first time:

Fill salt reservoir with approx. 2 quarts of water.

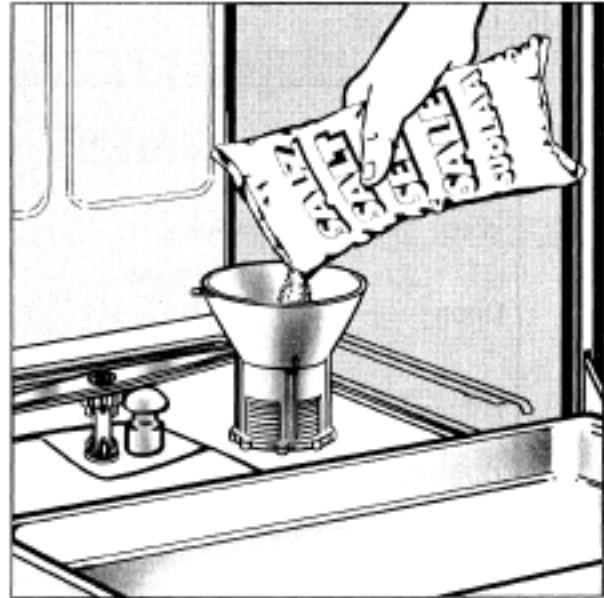

- Using the funnel provided, add salt (approx. 4.4 lbs.) up to the rim of the reservoir.
- Remove any grains of salt from the threaded union of the salt reservoir, replace plastic cap and tighten.

Immediately thereafter run the "Rinse & Hold Program" to remove any traces of salt from the cabinet.

This is not necessary if a normal program is run immediately.

Water Softener / Filling Salt Reservoir

“Salt” indicator

CHECK	SEQUENCE
Water Intake ○	Mins.
Drain — ○	Pre-wash 1
Salt — ○	2
Rinse aid ○	Main wash
	Post-rinse
	Final rinse
	Drying

Inside the screw cap of the salt reservoir is a green area indicating salt level.

If the green area in the screw cap drops below the appropriate level, the salt reservoir should be refilled.

Water Softener / Filling Salt Reservoir

Should the salt indicator light stay constantly on, the floater inside the cap of the salt reservoir may be blocked.

Remove the cap of the salt reservoir and rinse under hot water until green indicator is free to move. Replace cap.

If reactivation is not necessary due to low water hardness level, the salt indicator light on the control panel can be disengaged as follows:

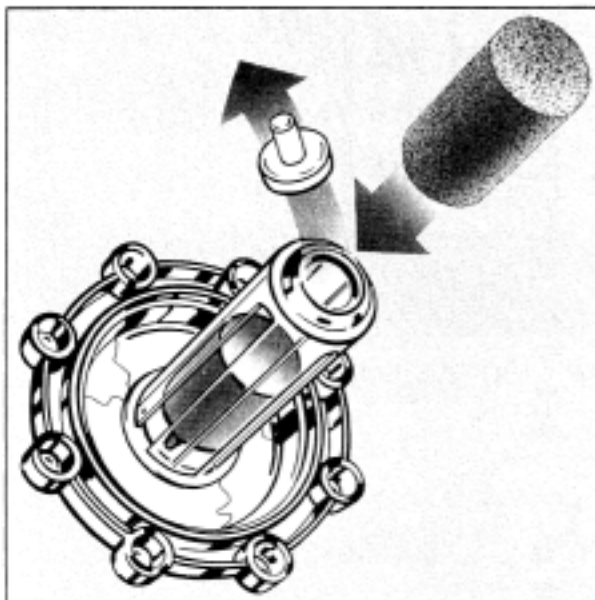

- Break out the bottom of the floater guide.
- Push the enclosed foam rubber piece through the bottom of the floater guide.

The floater then remains in the upper part and the indicator light is thus shut off.

Adding Rinse Aid

Rinse Aid is necessary for spotless dishes.

It is poured into the storage container and the required amount is automatically dispensed during the final rinse.

Inadvertently filling the rinse aid storage container with powder or liquid detergent always leads to damage to the storage container. Only pour rinse aid formulated for domestic dishwashers into the rinse aid storage container. Although it is possible to use household vinegar with at least 5% acid content, or liquid citric acid (up to 50% acid) as an alternative, the resulting rinsing and drying quality will not be as good as when rinse aid is used.

Do not use vinegar with a high acid content (e.g. vinegar essence 25% acid). This could damage the dishwasher.

When to add Rinse Aid (Liquid Jet Dry (Blue Liquid), commonly available in the USA).

- Add Rinse Aid when the indicator light Rinse Aid on the control panel comes on.

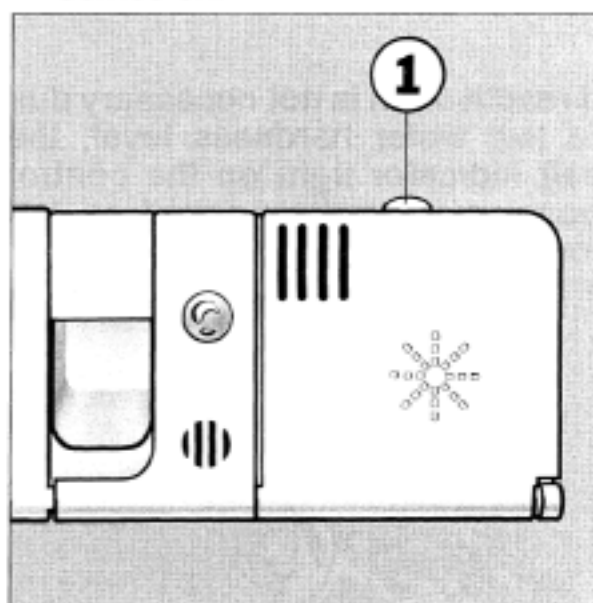

- Depress button until lid opens ①.

Adding Rinse Aid

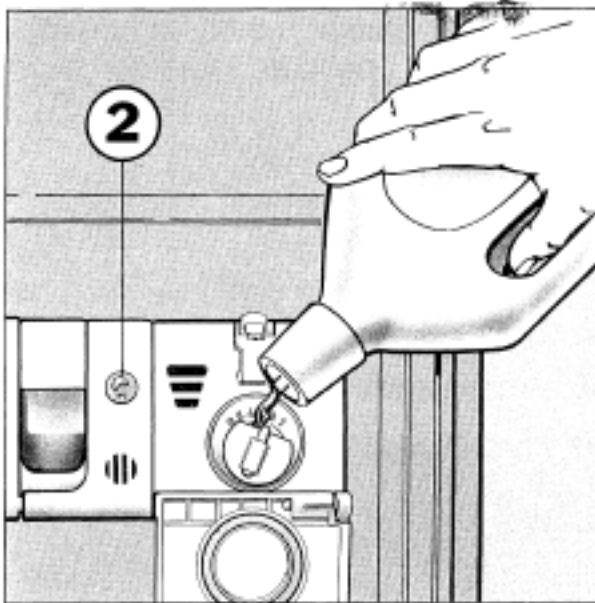

- Add Rinse Aid until top of level indicator gets dark ②.
- Close lid tightly, wipe off any excess Rinse Aid.

The lid is always closed at the end of the program!

Setting the dosage

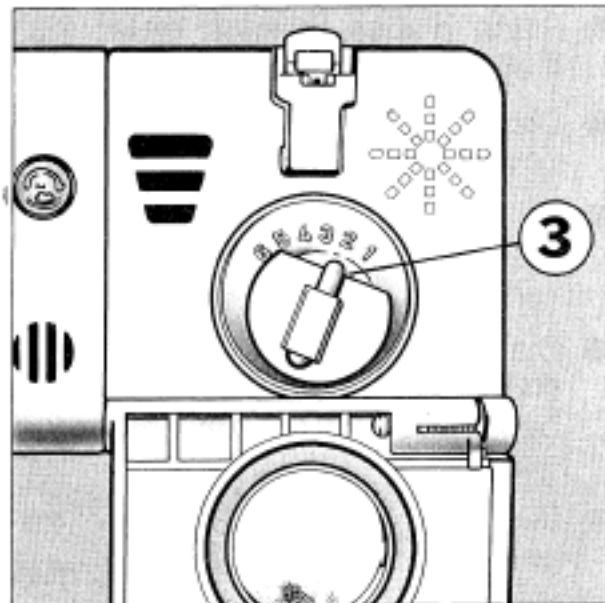

- To obtain the best drying results use the selector on setting 5.
- Set dosage selector ③ to higher setting when dishes show spots.
- Turn lower, if dishes are cloudy.

Loading Dishwasher

Please Note:

- Place dishes in such order that they can be rinsed from all sides.
- Dishes and cutlery should not cover each other.
- Hollow objects, such as cups, glasses and pots should be inverted.
- Dishes with recessed bottoms, such as cups, bowls, etc., should be placed in such a way that the water runs off.
- Place tall, narrow objects in the center basket.
- Do not cover small objects in top basket with larger ones, for example: place dessert cups on top of regular cups, not the other way around.
- Make sure not to cover up the inlet funnel to the spray arm in the center of upper basket.
- Do not block spray arms with tall objects. If necessary, manually rotate the arms to test them.

Upper Basket

The upper basket mainly accommodates small, delicate objects, such as:

- Cups
- Saucers
- Dessert Plates
- Glasses
- Small Bowls
- Heat-Resistant Plastic Ware

Lower Basket

The lower basket accommodates large objects, such as:

- Plates
- Saucepans
- Bowls

Glasses may only be cleaned in the lower basket fitted with special glassware insert.

Loading Dishwasher

Cutlery – for Dishwasher with Cutlery Tray (G 595 SC)

The cutlery tray ensures excellent cleaning and drying results, is easily loaded and prevents objects from getting scratched. The loading and unloading is especially hygienic as only the handles are touched. Sharp knives and forks do not then present a danger.

- It is recommended that the cutlery be arranged in zones, i.e. one zone for knives, forks, spoons and teaspoons, etc. This also makes unloading much easier.

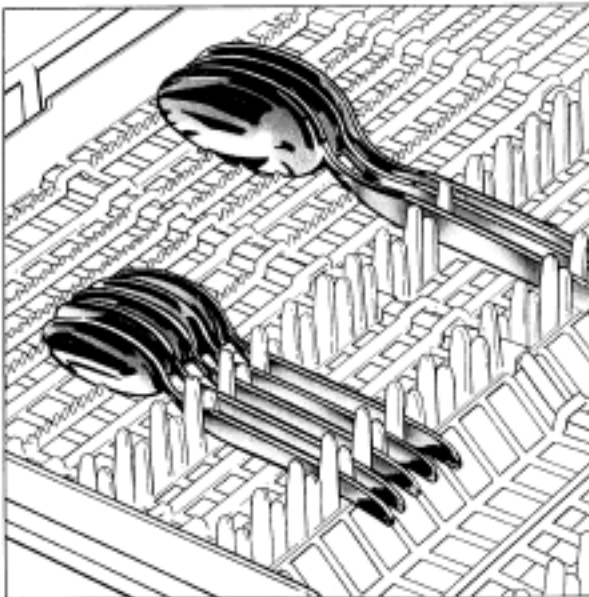

- Place spoons sideways into the grids so that water can easily drain off.

A variety of cutlery may be arranged in the cutlery tray. For instance: Spoons with round or oval handles can be placed the other way around, but make sure the water can easily drain off.

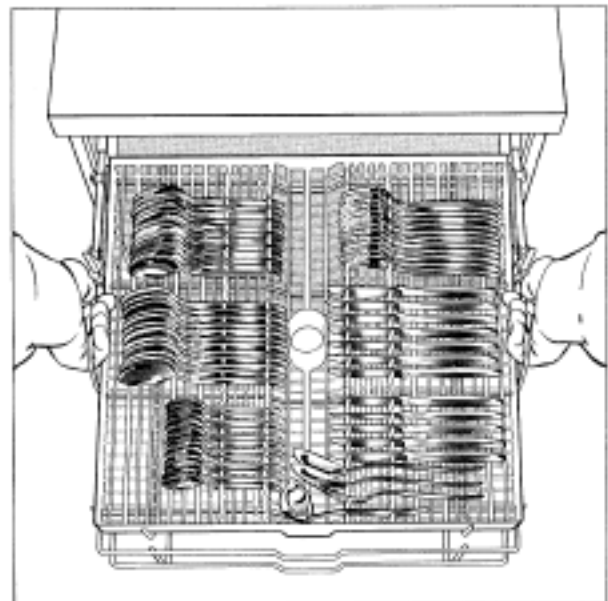
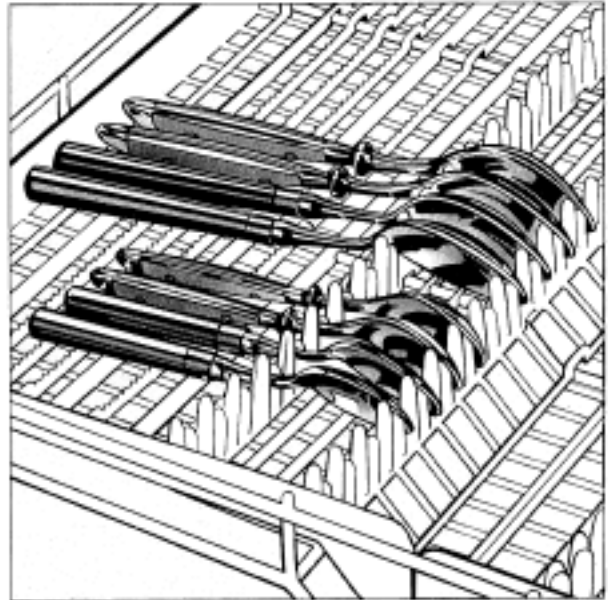

For your information: The cutlery tray is removable, thus making the removal of your cutlery easier.

Loading Dishwasher

Loading Examples: G 595 SC

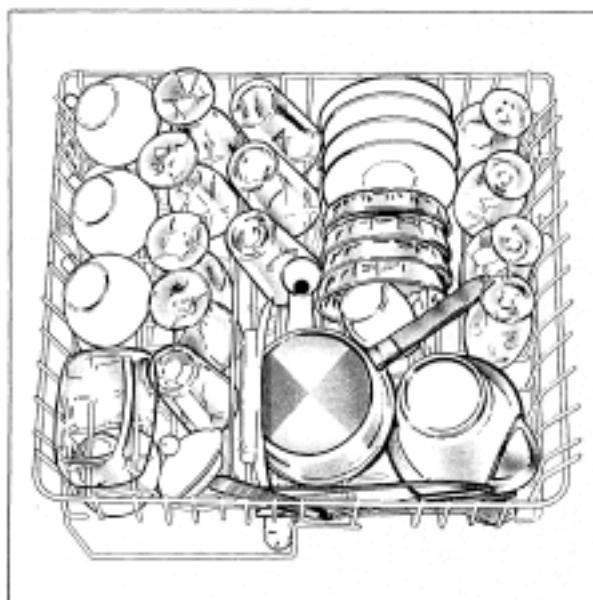

Upper Basket

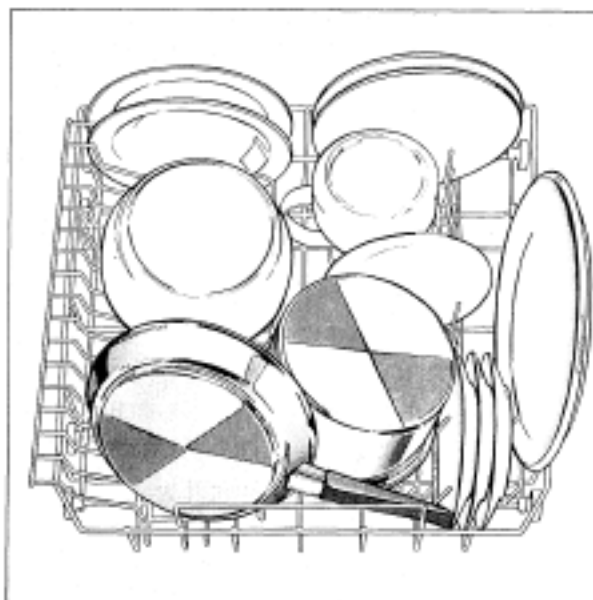

Lower Basket

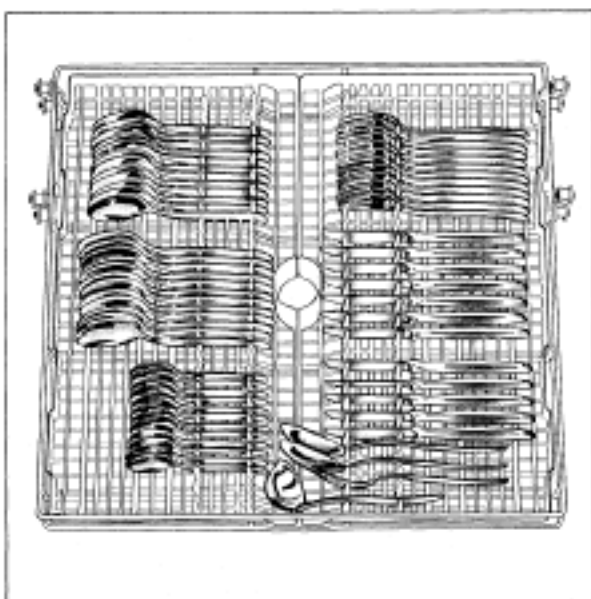

Cutlery Tray

Loading Dishwasher

Flip Rack

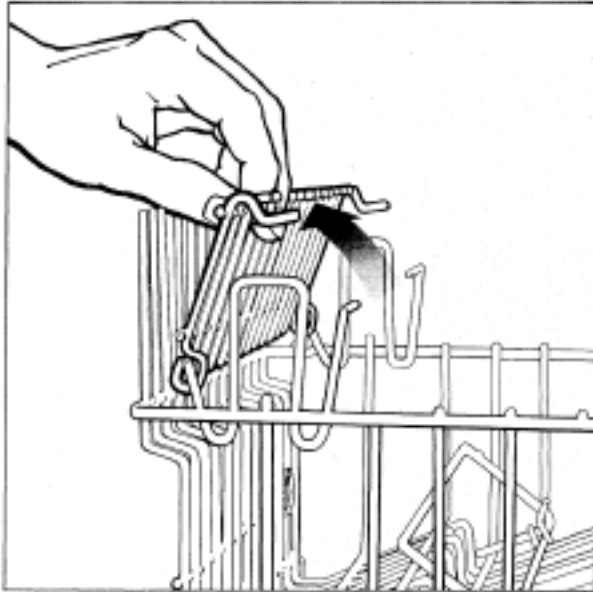

To arrange larger objects, the rack can be raised or left in down position to stack cups.

Bottle Accessory

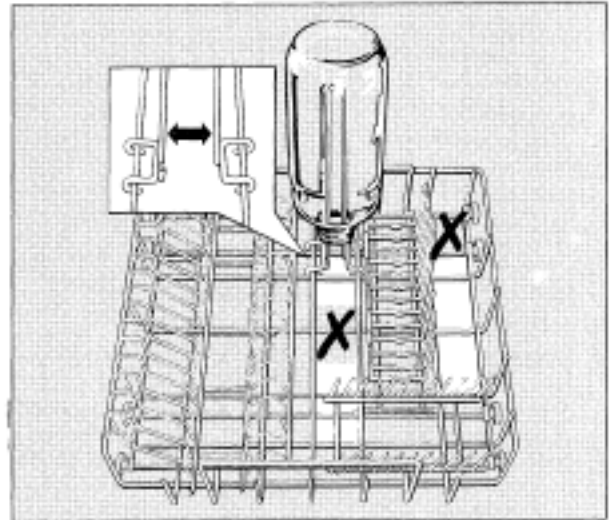

The bottle accessory can be attached at different places within the bottom basket.

Please note: The accessory can only be attached within the white areas – not on the "X" locations.

Loading Dishwasher

Upper Basket

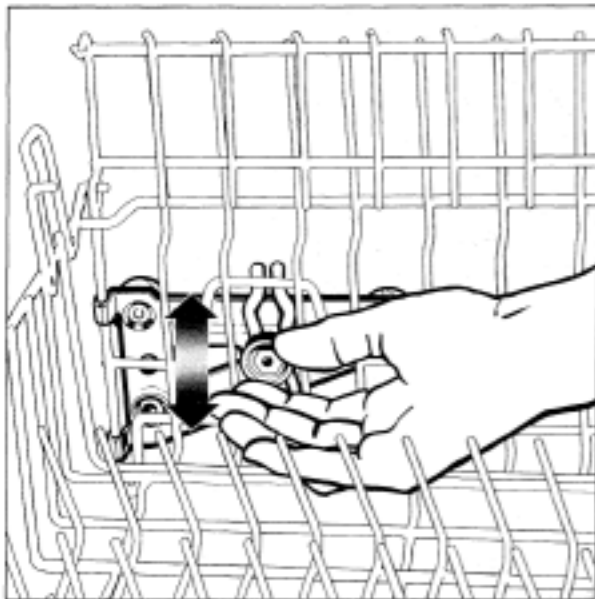

In order to make room for larger objects in the upper and lower baskets, the position of the upper basket can be changed.

- Pull out upper basket and loosen screws on both sides.
- Lift basket up or down, tighten the screws again.

In this position of the upper basket, plates of following diameters can be fitted (see table.)

Upper basket	Upper basket inch. Ø	Lower basket inch. Ø
Upper	6"	11.5"
Center	7"	11"
Lower	8"	10"

Not suitable for Dishwasher

- Utensils with wood or plastic handles.
- Wood or plastic objects and cutting boards may warp or split.
- Old knives, blades and handles of old knives may be glued together and therefore should not be cleaned in the dishwasher as the glue may not be heat-resistant.
- Handmade or craft items.
- Copper or tin items.
- Plastic articles may distort if they are not heat-resistant. Only wash plastic articles known to be heat-resistant in a dishwasher, in which case, use the top basket only.

When in doubt, wash by hand.

Please note:

Silver and aluminum articles when used with foods containing sulphur, may suffer some discoloration. Discolorations on silver cutlery can be removed with silver polish.

Painted dishes – over the glaze

Colors painted on over the glaze are generally produced in a quality which, bearing in mind the normal lifespan of the article, can be regarded as permanent.

With frequent use, fading of some delicate colors cannot always be entirely avoided.

If you are not sure whether the colors of a particular set of dishes are permanent, test wash one or two items which are already damaged for about four weeks.

MIELE recommends the following

- Glasses should only be washed using the 130° F (55° C) programs. The risk of damage to the surface of the glass, in the form of white clouding, increases with higher temperatures.
- Delicate glasses should only be washed using the "China & Crystal" program.
- Because very high temperatures can cause damage to your delicate crystal glasses, we recommend you wash these by hand, if your incoming water is above 115° F (45° C).
- When purchasing new dishes, make sure they are dishwasher-safe.

Adding Detergent

Detergent is poured into the dispenser before each program, except for "Rinse and Hold".

Use the correct dosage.

Only use detergents formulated for domestic dishwashers.

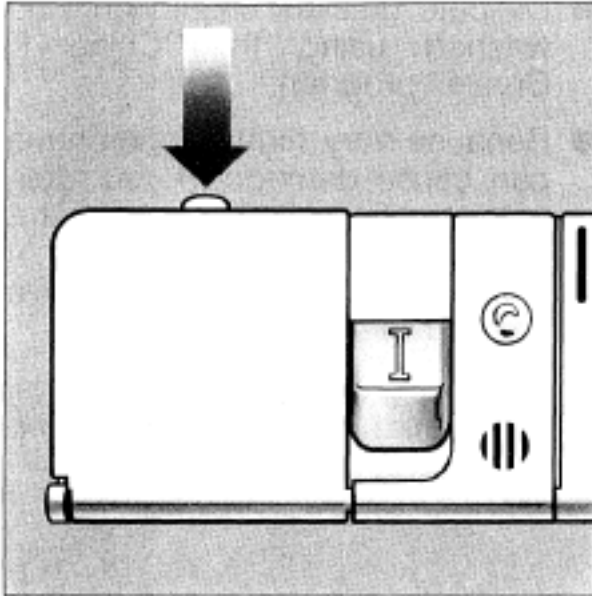

- Press the opening catch on the container flap forwards (see arrow). The flap will spring open. The flap is always open at the end of a program.

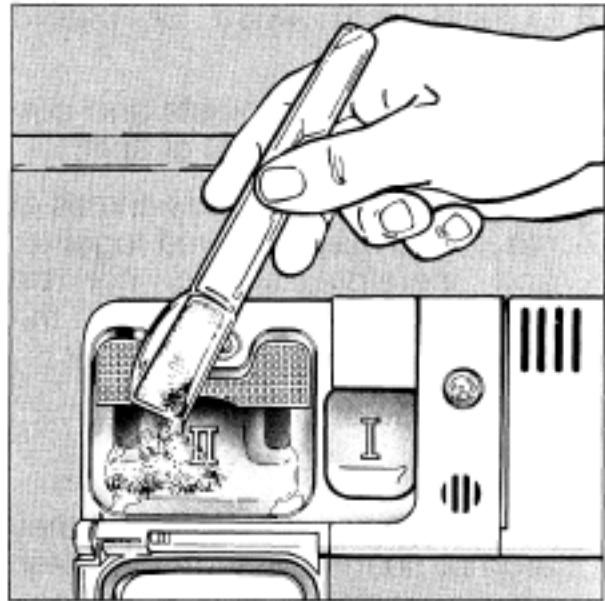

- Pour in the required amount of detergent. See p. 22.

Pre-wash in small compartment (I)
Main wash in large compartment (II)

- Shut the flap.

Note

Dishwasher detergent contains Sodium Silicate and Sodium Carbonate. In case of eye contact, immediately flush well with water. If swallowed, give large quantities of milk or water. Call a physician. Keep out of reach of children.

- The effectiveness of different detergents can vary. Therefore it may be necessary to add more detergent than is advised on page 22.
- If you buy detergent in bulk, check that the package is always properly sealed after use. Otherwise the detergent can lose its effectiveness.

Select a program according to type of dishes and degree of soils.

In most cases the "Normal" program is used.

- "Normal 130° F" or (with one pre-wash cycle)
- "Normal 160° F" (with one pre-wash cycle)

These programs are particularly suited for daily washings.

Special Programs

On the next page, various programs and their use are listed.

Types of Programs

Program	Application	Amount of detergent in oz.		Water Hardness
		Pre-wash	Main wash	
Universal Programs				
NORMAL 130° F	Select this program for normal soil of daily dishes.	1/6 1/6	2/3 5/6	1 + 2 3 + 4
NORMAL 160° F*	Same as above, but with a higher temperature for dried-on and starchy foods.	1/6 1/6	2/3 5/6	1 + 2 3 + 4
INTENSIVE 130° F	Same as "Normal 130° F", but with additional pre-wash cycle for heavily soiled dishes.	1/6 1/6	2/3 5/6	1 + 2 3 + 4
INTENSIVE 160° F	Same as "Intensive 130° F", but with higher temperature for dried-on and starchy foods.	1/6 1/6	2/3 5/6	1 + 2 3 + 4
Special Programs				
ECONOMY 130° F 1/2 load	For half-loaded baskets, with normal soils or fully loaded baskets with lightly soiled dishes, i.e. breakfast dishes.		1/2	1 - 4
ECONOMY 160° F 1/2 load	Same as above but with higher temperature for starchy foods.		1/2	1 - 4
POTS & PANS 160° F	For heavily soiled pots, pans with dried-on foods.	1/2	1	1 - 4
SHORT 115° F	"Fast Program", for lightly soiled dishes, i.e. party dishes.		1/2	1 - 4
CHINA / CRYSTAL 115° F	"Delicate Program" for lightly soiled, temperature-sensitive dishes.		1/2	1 - 4
RINSE & HOLD	For rinsing of odorous dishes when a complete program is not worthwhile.			

1) Electric consumption is based on incoming water at 130° F.

*) Comparison Program

?) for SC-Model: + 0,5 USG

Detergent scoop guide

The scoop for detergent has 4 divisions.

division 1 (lower) – 5 gr–1/6 oz
 division 2 (2nd) – 15 gr–1/2 oz
 division 3 (3rd) – 20 gr–2/3 oz
 division 4 (top) – 30 gr– 1 oz

Program sequence						Usage	
Pre-wash I	Pre-wash II	Main wash	Interim rinse	Final rinse	Drying	Electric kWh ¹⁾	Water GALLONS ²⁾
	○	○	○	○	○	0.8	6.3
	○	○	○	○	○	0.9	6.3
○	○	○	○	○	○	0.75	7.6
○	○	○	○	○	○	0.85	7.6
		○	○	○	○	0.65	4.7
		○	○	○	○	0.85	4.7
○	○	○	○	○	○	1.10	7.6
		○	○	○		0.28	4.7
	○	○	○	○	○	0.45	6.3
	○					0.06	2.1

Each division has the following values.

Switching ON and OFF

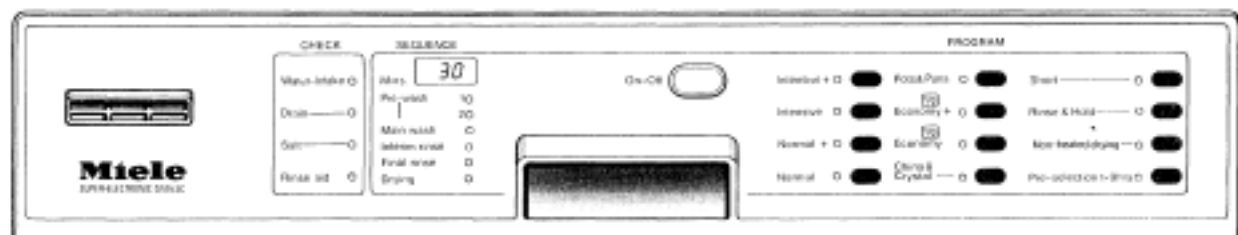

1. Switching ON

- Close door firmly until it clicks.
- Press On-Off button.

Switching OFF

- Press On-Off button and release.

2. Selecting Program

After switching on the dishwasher, the indicator lights next to the program buttons light up.

By depressing a program button, a program is started. All other programs are automatically blocked.

Changing Program

An accidentally selected wrong program can be changed as follows:

- Shut off the dishwasher, then switch on again.
- Select program.

3. Selecting Additional Programs

Immediately after selecting a program, two additional programs can be selected:

- "Non-heated drying"
- "Pre-selection 1-9 hrs".

Non-heated drying

In all programs, except "Rinse & Hold" and "Short", the drying process is supported by the "Turbothermic Drying" feature.

If you want drying without heating, press the button "Non-heated drying", so the heater is switched off during the drying cycle. The "Non-heated drying" function has to be chosen each time.

Switching ON and OFF

Pre-selection 1-9 hrs.

The start of a program can be delayed up to 9 hrs., for instance when making use of economical nighttime electricity.

- Select program, the timer shows the duration of the selected program in minutes; the program is started.
- Depress "Pre-selection 1-9 hrs" button 1 x per hour delay.

The timer now shows the program delay in hours.

Example: Depress 1 x = 1 hr. delay
Depress 2 x = 2 hrs. delay,
etc.

- Dishwasher will run for a few moments and will then stop. Delayed start is now programmed.

Program Sequence Indicator Light

After selection of program each stage is shown by the program sequence indicator.

1. Duration of program in minutes.

The timer counts backwards. By selecting a delayed start of a program, the remaining time is shown in hours.

2. The indicator light shows the program stage. When one program is finished, the indicator light goes off. When none of the indicator lights are lit and the timer shows "0", the program is finished.

To interrupt a program

The program is interrupted immediately when the door is opened. When the door is shut again the program continues from the point where it was interrupted.

Take care

If the water in the dishwasher is hot, there is a danger of scalding.

Only open the door if absolutely necessary, and then with greatest care.

Important

Lean, but do not close the door for 20 seconds before firmly shutting the door. This will keep a balanced temperature in the wash cabinet.

Unloading Dishwasher

- Hot dishes are sensitive to shocks. Therefore, allow dishes to remain in dishwasher for approximately 15 minutes to cool off.
- If the door is kept open, the load will cool off faster.
- Unload from the bottom upwards to prevent water from the cutlery or top basket from dripping onto the lower level.

Three additional functions can be programmed in, as desired.

**1.
More water – (60 sec. time-controlled)**

If water pressure is too low, not enough water enters the wash cabinet. The water inlet can then be time-controlled. This allows more water to enter.

IMPORTANT

When using the time-controlled water inlet, the water softener must be set 1 step higher than listed on page 8.

**2.
Turbothermic Drying**

During the drying phase, the dry warm air from the wash cabinet is redirected into the kitchen via vents on the control panel. Should this be inconvenient, the drying can be switched to convection.

**3.
Setting Timer for Cold Water Connection**

The timer is programmed for connection to hot water. If the dishwasher is connected to cold water, the program times are longer.

Programming Additional Functions (see next page).

Additional Functions

1. Water Inlet – lengthens fill time to compensate for low water pressure.

- Turn off dishwasher by pushing "On-Off" button to "Off" position.
- Press "Short", "Non-heated drying" button, and push "On-Off" button to "On", all at the same time. The letter "P" will display.
- Press "Intensive +" button and unit will display "10" or "11".
"10" (high water pressure)
"11" (low water pressure) – increases water level.
- Press "Non-heated drying" button and "10" changes to "11" or the other way around.
- Press "1-9 hrs" button. Unit displays "SP".
- Press "1-9 hrs" button again. The selection is now stored in memory.

2. Drying – vented or non-vented.

- Turn off dishwasher by pushing "On-Off" button to "Off" position.
- Press "Short", "Non-heated drying" button and push "On-Off" button to "On" position, all at the same time. The "P" will display.
- Press "Intensive" button. The unit displays "20" or "21".
"20" – regular, vented dry.
"21" – convection, non-vented dry.

NOTE: Generally #20 dries more thoroughly. Please use liquid "Blue Jet Dry", page 11.

- Press "Non-heated drying" button and "20" becomes "21" or the other way around.

- Press "1-9 hrs" button. Unit displays "SP".
- Press "1-9 hrs" button again. The selection is now stored in memory.

3. Cycle-time Display

The dishwasher has been programmed at the factory for hot water connection. If a cold connection is in effect, the cycle time will be much longer.

- To change the cycle from hot to cold, do the following:
- Turn off dishwasher by pushing "On-Off" button to "Off" position.
- Press "Short", "Non-heated drying" button and push "On-Off" button to "On" position, all at the same time. The "P" will display.
- Press "Normal". The timer displays "40" (hot water connection).
- Press "Non-heated drying" button and the timer will display "41" (cold water connection).
- Press "1-9 hrs" button. The timer displays "SP".
- Press "1-9 hrs" button once more. The selection is now stored in memory.

Cleaning and Care

Never wash dishes without the filters in place!

Cleaning the filters in the wash cabinet:

It is of utmost importance that the filters are kept clean:

Removing left-over soils

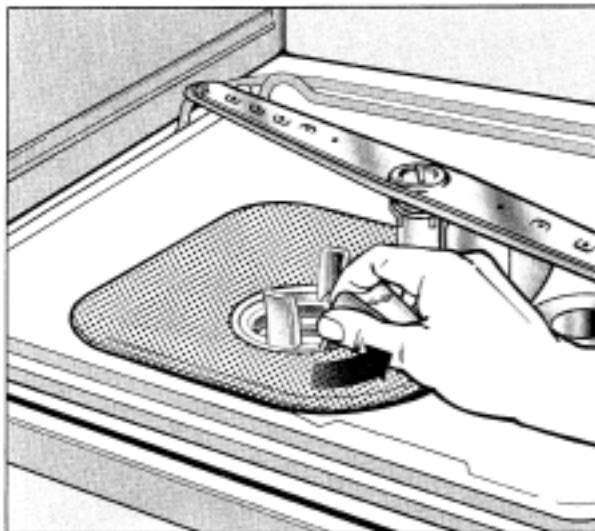

- Swing the handle to the right. This unlocks the filter combination.

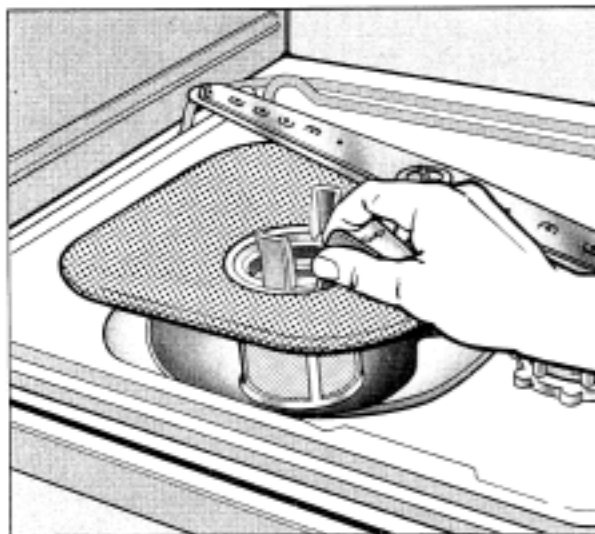

- Remove filter combination. Remove coarse soils and rinse under running water.

Most of the coarse soils are collected in the coarse filter. Cleaning of coarse filter is easier when it is removed from the micro-fine filter.

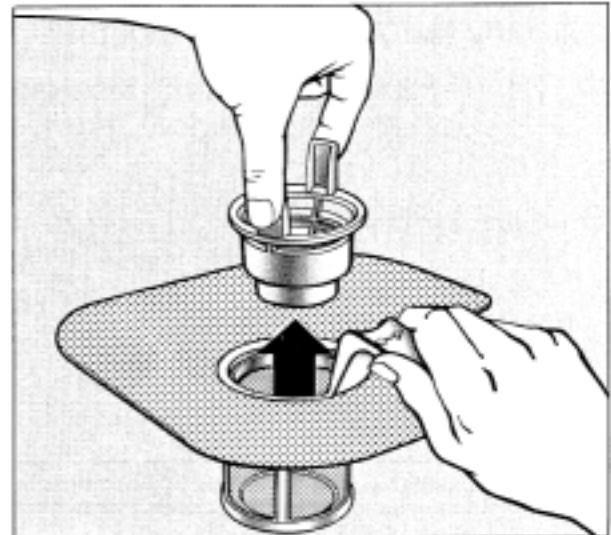

- To remove, gently squeeze tabs on top of filter towards middle and simultaneously pull filter out of place.
- When re-assembling, make sure that the coarse filter clicks into place.

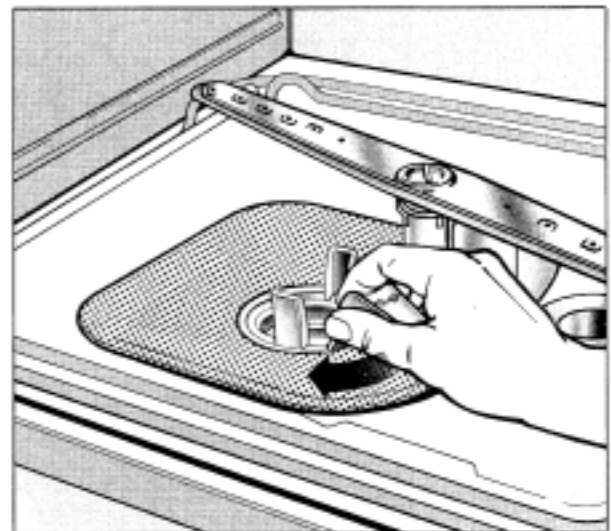

- Replace filter combination so that it lies flush on the floor of the wash cabinet. Swing the handle from right to left to lock in place.

Cleaning and Care

Cleaning the spray arms

Particles of food can get stuck in the spray arm jets. The spray arms should be inspected and cleaned regularly (approx. every 6 months).

- Remove all baskets and unscrew the upper and middle spray arms.
- In dishwashers with a cutlery tray the upper spray arm is easy to unscrew if the upper basket stays pushed in and just the cutlery tray is pulled out.

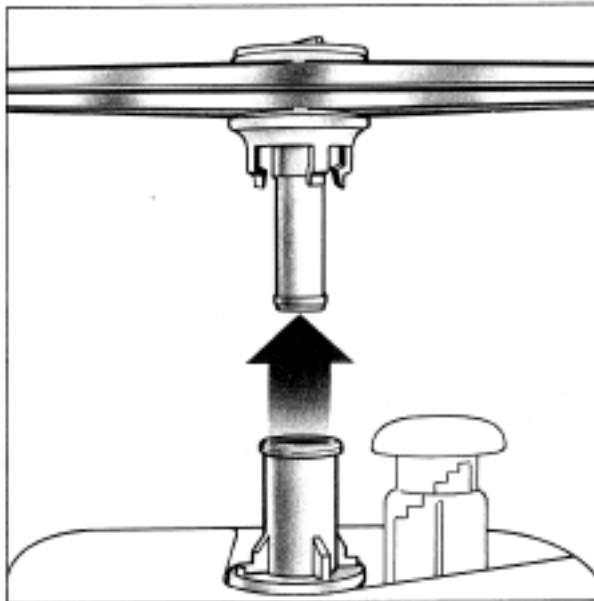

- Lift the lower spray arm upwards to remove it.

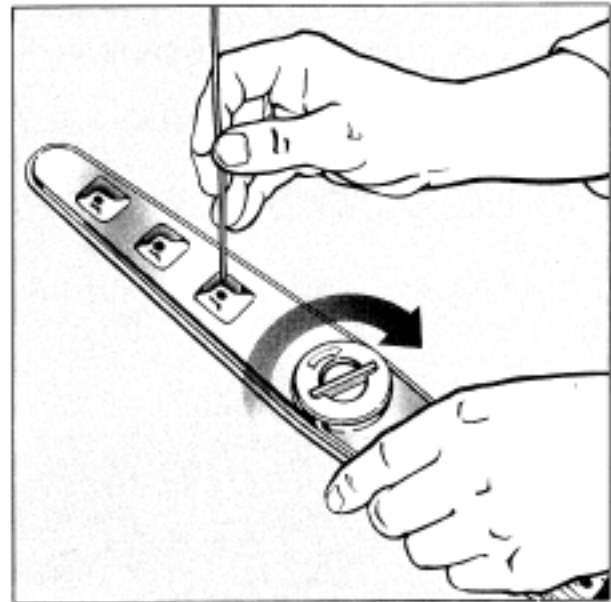

- The lower spray arm is easy to clean. Open the cap in the direction of the arrow (see illustration).
- Using a sharp, pointed object to push the food particles into the jets and rinse under running water.
- After cleaning, close up the cap again and push the spray arm firmly back in place.
- When replacing the upper spray arm, ensure the spray holes point upwards and the spray slits point downwards.
- After replacing the spray arms, check that they move freely.

Cleaning the drain pump and non-return valve

If water has not been pumped away at the end of a program the drain pump or the non-return valve might be blocked. They are, however, easy to clean.

- Take the filter combination out of the wash cabinet.

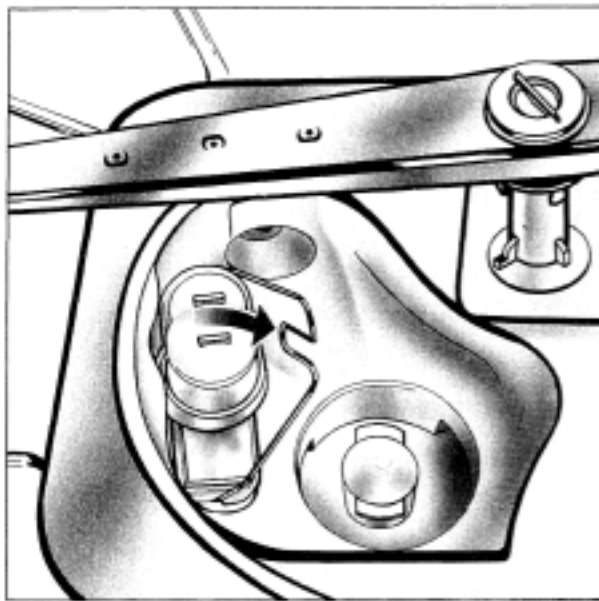

- Push the locking clamp towards the right and lift up the non-return valve.
- Rinse the non-return valve under running water.

The drain pump is situated under the non-return valve (see arrow).

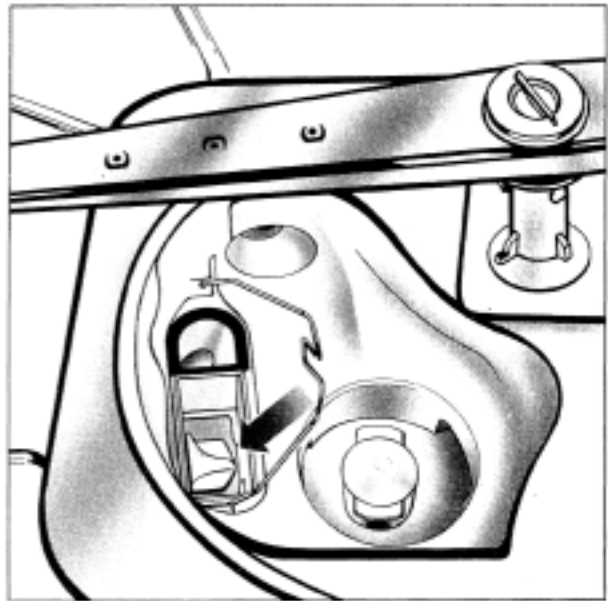

- Before replacing the non-return valve, check to make sure that nothing is obstructing the drain pump.
- Carefully replace the non-return valve and secure with the locking clamp.

Cleaning and Care

Cleaning the filter in the water inlet

A filter is incorporated in the screw connection of the valve on the water inlet hose. The filter must be cleaned when dirty, otherwise insufficient water flows into the wash cabinet.

Warning

The plastic housing of the water connection hose contains an electrical component. It must not be submerged in water.

To clean the filter

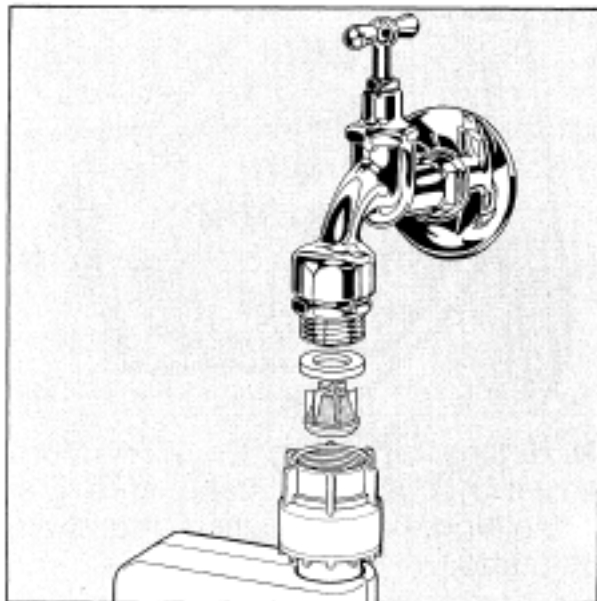

- Switch off the dishwasher.
- Turn off the water inlet tap and unscrew the inlet hose.
- Carefully remove the rubber seal.
- Remove the filter, using pointed pliers and clean.
- Replace filter and seal. Make sure they are sitting correctly.

- Screw back into the water inlet, taking care that it goes back on straight.
- Turn on the water inlet tap gradually to test for leaks. If there is a leak, screw the connections on more tightly.

Fitting an in-line water filter

If the water contains a large number of insoluble substances, we recommend fitting a filter in the connection between the water inlet tap and the water inlet hose. These filters can be obtained from the Miele Spare Parts Department (Part no. 75577).

Cleaning

- The control panel should only be wiped with a damp cloth.

Do not use a scouring agent.

- The front of the dishwasher should be cleaned with a product suitable for the type of front fitted.

Fronts made of wood should only be rubbed down with a damp cloth and dried.

Do not use any cleaning agent containing ammonia or thinners!

Dealing with Minor Faults

Fault	Check for possible causes
After starting program, the indicator lights light up. "Water inlet", the timer displays "0".	<ul style="list-style-type: none">● Is the water faucet fully turned on? <p>Remedy:</p> <ul style="list-style-type: none">● Shut off dishwasher.● Turn on water faucet.● Switch on dishwasher again and start up program.
The program ends prematurely, the indicator light indicates "Water Drainage"	<ul style="list-style-type: none">● The drainage hose is bent.● The pump is clogged. Clean pump (see page 31).
The program ends prematurely. The timer displays two horizontal dashes	<ul style="list-style-type: none">● Turn dishwasher first off then on again.● Select new program.● If the horizontal dashes reappear, the problem may be of technical nature; please consult the MIELE Service Department.
Dirty water accumulates in the wash cabinet.	<ul style="list-style-type: none">● The non-return valve is clogged. Clean the valve (see page 31).
Dishwasher does not start	<ul style="list-style-type: none">● Has the door been properly closed?● Is the plug correctly inserted into the outlet and is the fuse in order?
The dishes are not clean	<ul style="list-style-type: none">● Are the dishes correctly loaded?● Was the recommended amount of detergent used?● Has the water faucet (water supply) been fully turned on?● Are the filters in the wash cabinet clean (especially the micro-fine filter), and have they been correctly inserted?● Is the filter in the water inlet blocked? (see page 32)● Are the water inlet filters clean?● Spray arms may be clogged or blocked by large objects.

Dealing with Minor Faults

Fault

Check for possible causes

White film on dishes

- Salt container is empty
- Cap of salt container is not tightly closed.
- Not enough Rinse Aid

Should you still have difficulties, please contact your MIELE Dealer or the MIELE Service Department (see back cover for address) and give Type and Model of appliance. This information can be found on the data plate on inside of door.

The dishwasher must be installed correctly. Follow the installation guidelines in the separate booklet carefully.

- The dishwasher must be installed correctly and leveled accordingly. Any unevenness in the floor level can be compensated by adjusting the screw feet:

Adjustments

(Total height)

Standard Model **32½"**

Adjustable Height **34½"**

Building under

"U" and "i" models are designed specifically for building under a continuous countertop.

To ensure stability, these dishwashers must not be installed "free standing". They must be installed under a continuous countertop which has been firmly screwed to neighboring units.

On "i" models, the door panel should not weigh more than 12 lbs.

Electrical Connection

Electrical Connection

The appliance is delivered complete with cable and plug for A.C. (alternating current) electrical power 120 Volt, 60 Hz.

Connect the appliance only to a regular 15 Amp electrical outlet.

The appliance must be grounded and the connection must be done according to regulations and local codes.

Rated Load: 1.5 kW

Fuse Rating: 15 A

Connection Cable: Approx. 4' long.

All electrical work should be carried out by a qualified electrician in accordance with national and local regulations.

See separate installation instructions.

Water Connection

- The inlet hose is approx. 4' long; a longer hose (12') may be bought from the Miele Spare Parts Department.
- A shut-off valve with a $\frac{3}{8}$ " compression fitting connection is necessary or $\frac{3}{4}$ " male hose thread shut-off valve.
- For the Miele "Waterproof" leak protection system to function properly, the inlet hose must be connected to the shut off valve in the correct manner. Please follow the separate installation instructions for the "Waterproof system" unit.
- Water pressure must be between 14.5 PSI and 145 PSI. Max temp. 140° F.
In case of varying or extra low pressure, the MIELE Service Dept. will advise.

NB: The dishwasher is suitable for hot water connection.

Water drainage

- A non-return valve is built into the appliance to prevent dirty water from running back into the dishwasher.
- The appliance is equipped with a 4' long flexible hose, approx. $\frac{7}{8}$ " in diameter.
- Longer drain hoses are available.
- A hose clamp is enclosed for connection to drain system.
- The drainage hose should not be longer than 12' and pump height should not exceed 3'.
- The drainage hose should not be shortened.

Please follow the enclosed installation instructions carefully.

Technical Data

Height "U" and "I" Models:	32 ¹ / ₂ " – 34 ¹ / ₂ "
Width:	23 ⁵ / ₈ "
Depth:	22 ¹ / ₂ "
Depth "U" and "I" Models:	22 ¹ / ₂ "
Depth with open Door:	
"U" Model:	45 ¹ / ₂ "
"I" Model:	45 ¹ / ₂ "
Power Supply:	120 V, 60 Hz, 1-phase
Rated Load:	1.5 kW
Fuse Rating:	15 Amps
Water Pressure:	14.5 – 145 PSI
Hot Water Connection:	max. 140° F
Drainage Pump Height:	max. 3'
Drain Hose Length:	max. 12'

Miele®

Miele Appliances, Inc.
22-D World's Fair Drive
Somerset, NJ 08873
Tel. No. (908) 560-0899
Fax (908) 560-9649

Miele Appliances, Inc.
1900 S. Norfolk St.
San Mateo, CA 94403
Tel. No. (415) 571-9074
Fax. No. (415) 571-9188

Miele Appliances, Inc.
6400 Congress Rd.
Suite 1700
Boca Raton FL 33487
Tel. No. (407) 995-8030
Fax. No. (407) 995-8083

Copyright © 1991 Miele Appliances, Inc.
All Rights Reserved